

INSTRUCTION MANUAL

1. Safety Warnings

This instrument has been designed and tested according to IEC Publication 61010: Safety Requirements for Electronic Measuring Apparatus. This instruction manual contains warnings and safety rules which must be observed by the user to ensure safe operation of the instrument and retain it in safe condition. Therefore, read through these operating instructions when using the instrument.

⚠WARNING

Read through and understand instructions contained in this manual when using the instrument.

Save and keep the manual handy to enable quick reference whenever necessary.

Be sure to use the instrument only in its intended applications and to follow measurement procedures described in the manual.

Be sure to understand and follow all safety instructions contained in the manual.

Failure to follow the above instructions may cause injury, instrument damage and/or damage to equipment under test.

The symbol Δ indicated on the instrument means that the user must refer to related parts in the manual for safe operation of the instrument. Be sure to carefully read the instructions following each Δ symbol in this manual.

Δ **DANGER** : is reserved for conditions and actions that are likely to cause serious or fatal injury.

Δ **WARNING** : is reserved for conditions and actions that can cause serious or fatal injury.

Δ **CAUTION** : is reserved for conditions and actions that can cause injury or instrument damage

Following symbols are used on the instrument and in the instruction manual. Attention should be paid to each symbol to ensure your safety.

Δ Refer to the instructions in the manual.

This symbol is marked where the user must refer to the instruction manual so as not to cause personal injury or instrument damage.

\square Indicates an instrument with double or reinforced insulation.

\square Indicates that this instrument can clamp on bare conductors when measuring a voltage corresponding to the applicable Measurement category, which is marked next to this symbol.

\sim Indicates AC (Alternating Current).

\equiv Indicates DC (Direct Current).

\sim \equiv Indicates AC and DC.

⚠DANGER

Never make measurement on a circuit above 600V AC.

Do not attempt to make measurement in the presence of flammable gasses, fumes, vapor or dust. Otherwise, the use of the instrument may cause sparking, which can lead to an explosion.

Transformer jaw tips are designed not to short the circuit under test. If equipment under test has exposed conductive parts, however, extra precaution should be taken to minimize the possibility of shorting.

Never attempt to use the instrument if its surface or your hand is wet.

Do not exceed the maximum allowable input of any measurement range.

Never open the battery compartment cover when making measurement.

Never try to make measurement if any abnormal conditions, such as broken Transformer jaws or case is noted.

The instrument is to be used only in its intended applications or conditions. Otherwise, safety functions equipped with the instrument doesn't work, and instrument damage or serious personal injury may be caused.

⚠WARNING

Never attempt to make any measurement, if the instrument has any structural abnormality such as cracked case and exposed metal part.

Do not install substitute parts or make any modification to the instrument. Return the instrument to Kyoritsu or your distributor for repair or re-calibration.

Do not try to replace the batteries if the surface of the instrument is wet.

Remove the test leads from the instrument before opening the bottom case for battery or fuse replacement.

⚠CAUTION

Make sure that the range switch is set to an appropriate position before making measurement.

Always make sure to insert the plug of each test lead fully into the appropriate terminal on the instrument.

When the instrument will not be in use for a long period of time, place it in storage after removing the batteries.

Do not expose the instrument to the direct sun, extreme temperatures or dew fall.

Use a damp cloth and detergent for cleaning the instrument. Do not use abrasives or solvents.

○Measurement categories(Over-voltage categories)

To ensure safe operation of measuring instruments, IEC61010 establishes safety standards for various electrical environments, categorized as CAT I to CAT IV, and called measurement categories.

Higher-numbered categories correspond to electrical environments with greater momentary energy, so a measuring instrument designed for CAT III environments can endure greater momentary energy than one designed for CAT II

CAT. I : Secondary electrical circuits connected to an AC electrical outlet through a transformer or similar device.

CAT. II : Primary electrical circuits of equipment connected to an AC electrical outlet by a power cord.

CAT. III : Primary electrical circuits of the equipment connected directly to the distribution panel, and feeders from the distribution panel to outlets.

CAT. IV : The circuit from the service drop to the service entrance, and to the power meter and primary over-current protection device(distribution panel).

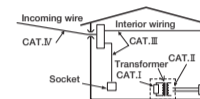

AC CLAMP METER WITH DC VOLT RANGE

KEW SNAP 6

KEW SNAP 2608A

Easy to use and dependable, the instrument is especially designed to incorporate as many safety features as possible.

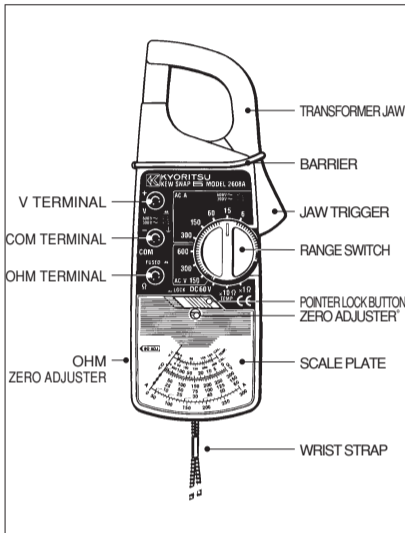

KYORITSU ELECTRICAL INSTRUMENTS WORKS, LTD

3. Specifications

Measuring Range and Accuracy

	Ranges	Accuracy
AC current	6/15/60/150/300A	±3% of full scale
AC voltage	150/300/600V	±3% of full scale
DC voltage	60V	±3% of full scale
Resistance	×1 Ω, 1k Ω (25 Ω mid-scale) ×10 Ω, 10k Ω (250 Ω mid-scale)	±2% of scale length
Temperature	-20~+150°C (with optional Model 7060)	±5°C(0~+100°C) ±10°C (other ranges)

Overload Protection

Range	Maximum overload
AC6/15A	60A AC for 10 sec
AC60/150A	300A AC for 10 sec
AC300A	360A AC for 10 sec
AC150/300V	600V AC for 10 sec
AC600V	720V AC for 10 sec
DC60V	230V AC for 10 sec
×1 Ω/×10 Ω	230V AC, protection by fuse

Location for use :Indoor use, Altitude up to 2000m

Storage Temperature and Humidity :-10~+50°C, relative humidity up to 75% without condensation

Operating Temperature and Humidity :0~+40°C, relative humidity up to 90% without condensation

Conductor Size Safety Standard :Approx. 33mm diameter max. IEC61010-1 CAT.III 300V CAT.II 600V IEC61010-2-031 IEC61010-2-032

Withstand Voltage :3700V AC for 1 minute between electrical circuit and housing cases or metal parts of jaws

Dimensions Weight PowerSource :193(L)×78(W)×39(D)mm :Approx.275g(battery included) :R6P(DC1.5V) battery or equivalent

Accessories (included) :Instruction manual Carrying case Model 9052 Test leads Model 7066 R6P battery(included within the instrument) Two 0.5A/600V fuses(spare fuse included) (optional) :Model 8004,8008(Multi-Tran) Model17060(temperature probe)

4. Preparation for Measurement

4-1 Releasing Pointer Lock

Slide the pointer lock button to the right position to unlock the pointer.

4-2 Meter Zero Adjustment

Set the pointer at the center of the "0" mark on the scale by rotating the zero adjuster with a screw driver.

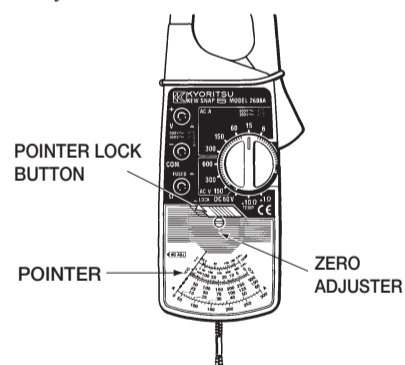

4-3 Checking Battery Voltage

a. Set the range switch to the "×1 Ω" position.

b. Insert the red test lead into the OHM terminal and the black test lead to the COM terminal.

c. With the test leads shorted, try to set the pointer over the "0" mark at the right end of the resistance scale, using the OHM zero adjuster.

d. When the adjustment brings the pointer over the "0" mark, proceed to measurement. If not, replace the battery. (See section 7 for battery and fuse replacement.)

NOTE

• The battery is needed only in resistance measurement. AC/DC voltage and AC current measurement can be made without the battery.

• If the instrument does not operate properly even after battery replacement, check the fuse and test leads.

5. Measurement

5-1 AC Current Measurement

⚠WARNING

• Do not make measurement on a circuit above 600V AC. This may cause shock hazard or damage to the instrument or equipment under test.

• Transformer jaw tips are designed not to short the circuit under test. If equipment under test has exposed conductive parts, however, extra precaution should be taken to minimize the possibility of shorting.

• Do not make measurement with the bottom case removed.

• Do not make current measurement with the test leads connected to the instrument.

• Do not measure current exceeding the limit for the overload protection feature.

• Keep your fingers and hands behind the barrier during measurement.

⚠CAUTION

• When the order of the current under test is not known, make measurement first on the highest 300A range, then switch to the appropriate range.

a. Set the range switch to the "AC 300A" position.

b. Press the trigger to open the transformer jaws and clamp onto one conductor only. It is recommended that the conductor be placed at the center of the closed jaws.

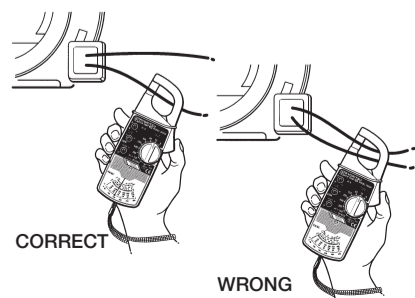

2. Features

Tear-drop-shaped jaws for ease of use in crowded cable areas and other tight places Safety design throughout. Designed to CAT.III 300V/CAT.II 600V and pollution degree 2 specified by the international safety standard IEC 61010.

DC voltage range especially useful for checking a power supply for emergency use Pointer lock feature for easy reading in dimly light or hard-to-read locations

Uses shrouded transformer jaws to further improve safety

Optional temperature probe for temperature measurement

c. Take the reading on the 300A current scale.

d. Set the range switch to the appropriate position based on the reading.

e. Take the reading on the appropriate scale.

Range	Scale used	Multiply reading by
A C 6A	60A	×0.1
A C 15A	150A	×0.1
A C 60A	60A	×1
A C 150A	150A	×1
A C 300A	300A	×1

NOTE

• During current measurement, keep the transformer jaws fully closed. Otherwise, accurate measurement cannot be made. The maximum conductor size is 33mm in diameter.

• When measuring a larger current, the transformer jaws may buzz. This is not a fault and does not affect the accuracy at all.

5-2 AC Voltage Measurement

⚠WARNING

• Do not make measurement on a circuit above 600V AC. This may cause shock hazard or damage to the instrument or equipment under test.

• Do not make measurement with the bottom case removed.

• Do not apply to the instrument voltage exceeding the limit for the overload protection feature.

• Keep your fingers and hands behind the barrier during measurement.

a. Set range switch to an AC voltage position. When the order of the voltage under test is not known, set the range switch to the highest 600V range.

b. Insert the red test lead to the V terminal and the black test lead to the COM terminal.

c. Connect the tip of the test leads to the circuit under test.

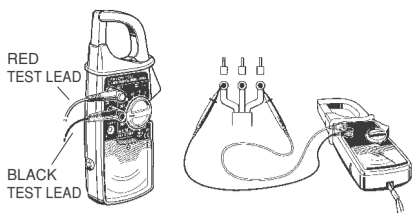

- Take the reading on the scale for the selected range.
- After completing the measurement, remove the test leads from the circuit under test.

Range	Scale used	Multiply reading by
AC150V	150V	×1
AC300V	300V	×1
AC600V	60V	×10

5-3 DC Voltage Measurement

⚠WARNING

- Do not make measurement on a circuit above 60V DC.
- Do not make measurement with the bottom case removed.
- Keep your fingers and hands behind the barrier during measurement.

- Set range switch to the "DC 60V" position.
- Insert the red test lead to the V terminal and the black test lead to the COM terminal.
- Connect the red test lead tip to the positive side of the circuit under test and the black test lead tip to the negative side.
- Take the reading on the 60V scale.
- After completing the measurement, remove the test leads from the circuit under test.

5-4 Resistance Measurement

⚠WARNING

- Do not make measurement with the bottom case removed.
- Make sure that there is no voltage in the circuit or equipment under test.
- Keep your fingers and hands behind the barrier during measurement.

⚠CAUTION

- Make sure to remove the test leads from the terminals when resistance measurement is over. If the test leads are left inserted to the terminals, their inadvertent shorting can exhaust the battery.

- Set the range switch to the "×1Ω" or "×10Ω" position.
- Insert the red test lead to the OHM terminal and the black test lead to the COM terminal.
- With the test leads shorted, set the pointer over the "0" mark at the right end of the resistance scale, using the OHM zero adjuster.

BLACK TEST LEAD

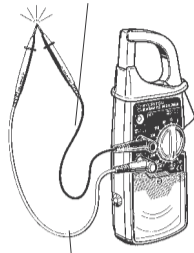

RED TEST LEAD

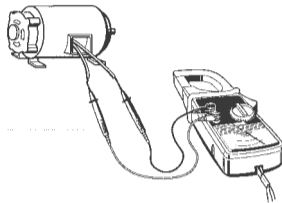

- Connect the tip of the test leads to the circuit under test.
- Take the reading on the resistance scale and multiply it as follows.

Range	Scale used	Multiply reading by
×1Ω	Ω	×1
×10Ω	Ω	×10

8. Optional Accessories

Model 8004 and 8008 (Multi-Tran)
Multi-Tran extend existing current measuring range up to 3000A as well as the maximum conductor size.

⚠WARNING

- Do not make measurement on a circuit above 600V AC.
- The transformer jaws are made of metal and their tips are not insulated. Never touch the exposed metal parts under test with jaw tips.
- Do not make measurement with the bottom case removed.
- Do not make measurement with the test leads connected to the instrument.

⚠CAUTION

- When the order of the current under test is not known, make measurement first on the highest 300A range, then switch to the appropriate range.

- Set the range switch to the desired position.
- Clamp Kew Snap 2608A onto the pick-up coil of Multi-Tran.
- Clamp Multi-Tran onto the bus-bar or conductor under test.
- Take the reading on Kew Snap 2608A and multiply it by 10.

Models	Max. conductor size (mm in diameter)	Measuring range	Input to output ratio
Model8004	φ 60	AC0~1000A	10:1
Model8008	φ 100	AC0~3000A	10:1

Model 7060

Model 7060 is a temperature probe with a measuring range from -20°C to +150°C.

⚠WARNING

Do not make measurement on a metal part with a voltage more than 30V AC or 60V DC.

6. Using Pointer Lock

The pointer lock feature can be used for measurement in dimly light or hard-to-read locations.

- Make AC current, AC voltage, DC voltage or resistance measurement as described in section 5.

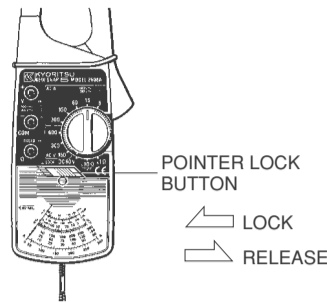

- Slide the pointer lock button to the left position.
- Take the reading away from the conductor or the circuit under test.
- To release the pointer lock, slide the button to the right.

7. Battery and Fuse Replacement

⚠WARNING

- To avoid electric shock hazard, make sure to remove the test leads from the instrument before trying to replace batteries.
- Make sure to screw the bottom case back onto the instrument after battery or fuse replacement.
- Do not install a battery or fuse that does not have the specified rating.

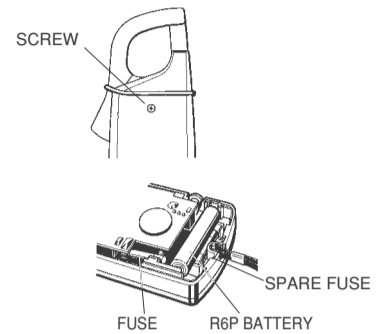

7-1 Battery Replacement

- Remove the test leads from the instrument.
- Remove the screw on the back side of the bottom case to open the instrument.
- Replace the battery with a new R6P battery or equivalent. The new battery must be installed in the orientation indicated inside the instrument.
- Screw the bottom case back onto the instrument.

7-2 Fuse Replacement

The instrument's resistance measuring circuit is protected by a 0.5A/600V fuse. When the instrument does not operate properly in resistance measurement, check the fuse and replace it in the following steps, when necessary.

- Remove the test leads from the instrument.
- Remove the screw on the back side of the bottom case to open the instrument.
- Replace the blown fuse with the spare fuse installed beneath the battery.
- Screw the bottom case back onto the instrument.

- Set the range switch to the "TEMP (×10Ω)" position.
- Insert the red test lead to the OHM terminal and the black test lead to the COM terminal.
- With the test leads shorted, set the pointer over the "0" mark at the right end of the resistance scale, using the OHM zero adjuster.
- Remove the test leads from the terminals.
- Insert Model 7060's red plug to the OHM terminal and the black plug to the COM terminal.
- Touch the tip of the temperature probe to the part under test.
- Wait until the reading become stable, then take the reading on the temperature scale.

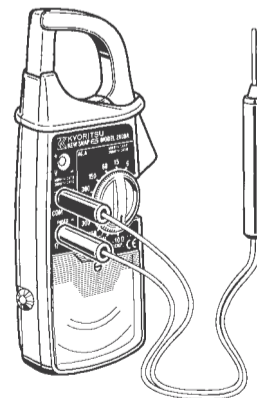

9. After-sales Service

9-1 Sending for Repair

Make sure to provide description of the failure and your name, address and telephone number. Pack the instrument securely so that it will not be damaged during transportation and forward it to your distributor.

9-2 Periodic Calibration

In order to maintain measurement accuracy, it is recommended that you forward the instrument to Kyoritsu Repair Center for calibration once every year.

NOTE:

Calibration is charged.

KYORITSU reserves the rights to change specifications or designs described in this manual without notice and without obligations.



KYORITSU ELECTRICAL INSTRUMENTS WORKS, LTD.
No.5-20, Nakane 2-chome, Meguro-ku, Tokyo, 152-0031 Japan
Phone: +81-3-3723-0131
Fax: +81-3-3723-0152
Factory: Ehime

www.kew-ltd.co.jp